





# Serie Special MA<sub>3</sub>RK 220

Certificato per:

 Usage cycles **200.000**

Protegge da:

-  Aria
-  Acqua
-  Luce
-  Insetti

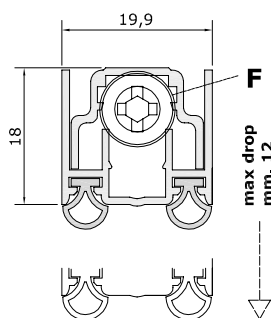
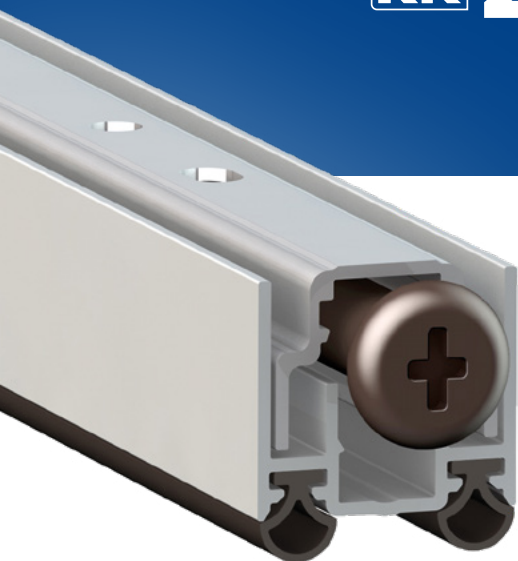

 Non costituisce ostacolo ai disabili

## ACCESSORI STANDARD

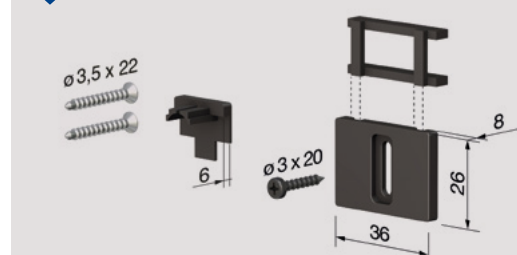

Misure standard (mm)	330	430	530	630	730	830	930	1030	1130	1230	1330
Max accorciabilità (mm)	130	130	200	200	200	200	200	200	200	200	200

## SISTEMA DI FISSAGGIO

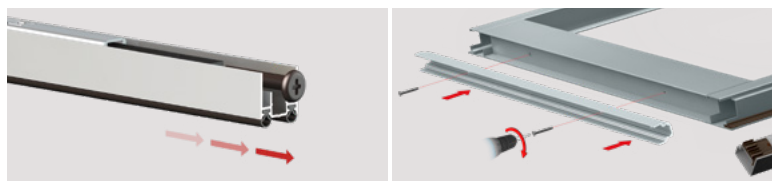

Sfila e avvita

 Meccanismo con una singola regolazione (vite F: discesa) caratterizzato dal movimento controllato del profilo mobile con guarnizione (discesa immediata dal lato cerniere della porta e conseguente discesa graduale per tutta la lunghezza) per un adeguamento al pavimento.

 **STANDARD:** Scatola di cartone con 30 pz. + 30 confez. accessori standard.

## APPLICAZIONI PRINCIPALI



Porta in alluminio

 Profili estrusi in lega di alluminio 6060 - doppia guarnizione tubolare estrusa in neoprene - elementi stampati in nylon autolubrificante + nylon caricato al 30% con fibra di vetro - barrette filettate in ferro brunito - boccola Ø 5 mm in ottone - molle elicoidali in acciaio inox trattato.

## ACCESSORI OPZIONALI

Dettagli a pagina 102

### 1 Piastre in nylon

CA104				 Confezione 100 pz.
CA201	CA202	CA203	CA204	 Marrone, bianco
CA205	CA207			

### 2 Piastre isolanti in nylon con guarnizione in silicone

PI001	PI002	PI002-R	 Confezione 20 pz.
PI003	PI004	PI005	 Marrone, bianco

### 3 Sistema di fissaggio con squadrette

SCN001	SCN001B-220NS	 Confezione 20 pz.
		 Acciaio, marrone

### Esempi di applicazione

Telaio con nervature

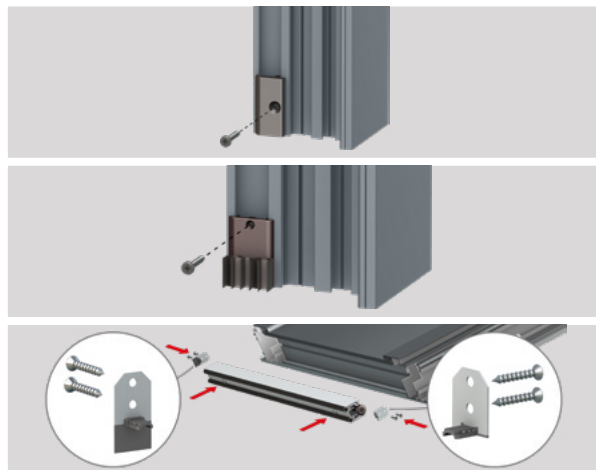

 **PULSANTE (F):** esagonale in ottone, quadrato in nylon, smussato in nylon, rolling in nylon (pivot).

 **OPTIONAL:** Scatola di cartone con 15 buste in polietilene da 1 pezzo + 1 confezione di accessori standard + istruzioni di montaggio.